

hex 19

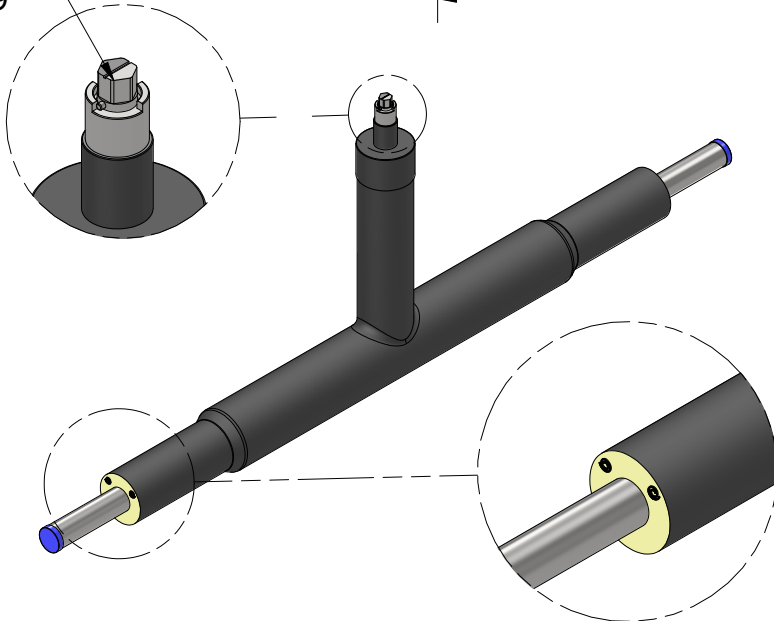

The impulse (Nordic) alarm wire is installed only along the main pipeline.

product code: GLOBTOS VP 25/90		manufacturer: FWBV.com Fully Welded Ball Valves	
product name: GLOBTOS preinsulated ball valve dn25 pe90, hex19		prepared for: GLOBTOS valve technology	
www.GLOBTOS.com		pl@globtos.com +48726500100	
drawn by: Janusz Ośmiałowski	date: 01.02.2024	scale: 1:8	notes:
checked by: Tomasz Ośmiałowski	version: 1.0	sheet size: A4	
approved by: Jacek Pawlikowski	weight: kg	unit: mm	