

hex 19

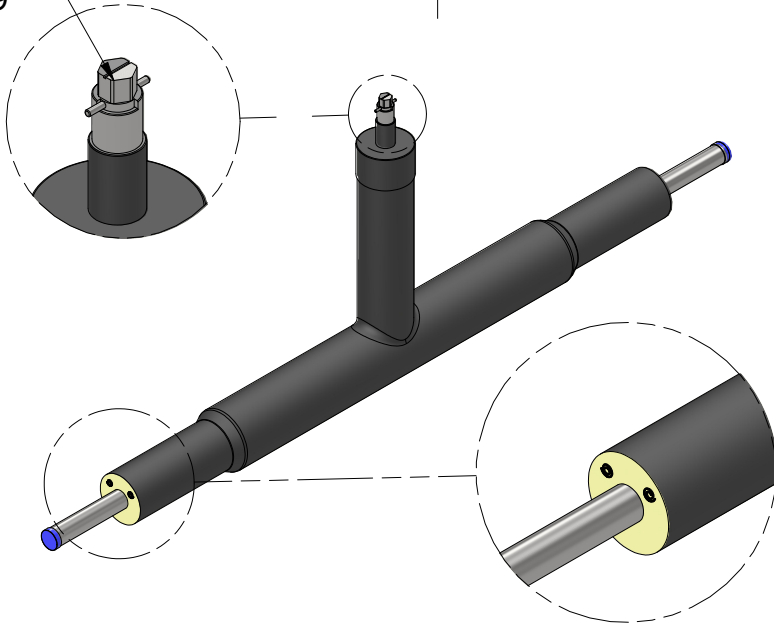

The impulse (Nordic) alarm wire is installed only along the main pipeline.

product code: <b>GLOBTOS VP 25F/90</b>		manufacturer: <b>FWBV.com</b> Fully Welded Ball Valves	
product name: <b>GLOBTOS preinsulated ball valve dn25 full bore, pe90, hex19</b>		prepared for: <b>GLOBTOS</b> valve technology	
www.GLOBTOS.com pl@globtos.com +48726500100			
drawn by: Janusz Ośmiałowski	date: 01.02.2024	scale: 1:8	notes:
checked by: Tomasz Ośmiałowski	version: 1.0	sheet size: A4	
approved by: Jacek Pawlikowski	weight: kg	unit: mm	